

# Data sheet | Item number: 765-4501/100-000

8-Port-IO Link Master Class A; EtherNet/IP; DC 24 V / 2.0 A; 8xM12 connection; WideLine

[www.wago.com/765-4501/100-000](http://www.wago.com/765-4501/100-000)



**i** Picture differs from the item.

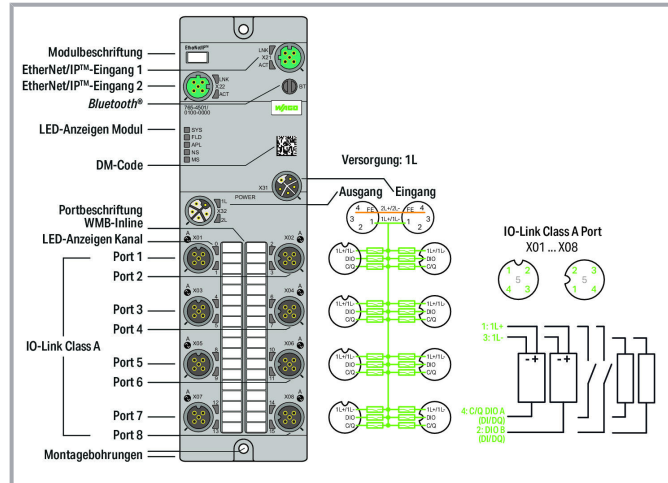

## Data

### Technical data

### Fieldbus

|   |                                     |
|---|-------------------------------------|
| Communication                                 | EtherNet/IP™<br>BOOTP, DHCP, DLR    |
| Connection technology: communication/fieldbus | 2 x D-coded M12; 4-pole             |
| Interface standard                            | 10BASE-T/100BASE-TX; potential-free |
| Autonegotiation; autocrossover                | yes                                 |

### Device Functions

|            |                                |
|------------|--------------------------------|
| Parameters | Input filter<br>Output current |
|------------|--------------------------------|

Subject to changes. Please also observe the further product documentation!

WAGO GmbH & Co. KG  
 Hansastr. 27  
 32423 Minden  
 Phone: +49571 887-0 | Fax: +49571 887-169  
 Email: [info.de@wago.com](mailto:info.de@wago.com) | Web: [www.wago.com](http://www.wago.com)

Do you have any questions about our products?  
 We are always happy to take your call at +49 (571) 887-44222.



|                  |  |
|------------------|--|
|                  | Temperature  |
| Diagnostics      | Undervoltage; Overcurrent; Overload; Overtemperature |
| Device functions | Bluetooth®<br>OPC UA Server                          |
| Visualization    | Android/iOS app<br>Webserver                         |

## IO-Link Master

|                               |  |
|-------------------------------|--|
| IO-Link Master classification | Class A; Specification V1.1  |
| Port mode                     | IO-Link: autoconfig, manual, tool-based<br>DI<br>DO  |
| Cycle time                    | 400 µs (min.)  |
| Operating mode                | IO-Link master, DI or DO (adjustable for pin 4 per port); DI or DO (adjustable for pin 2 per port) |

## IO-Link ports

|                                       |   |
|---------------------------------------|---|
| Number of digital inputs              | 16                                      |
| Number of digital outputs             | 16                                      |
| Connection technology: inputs/outputs | 8 x A-coded M12; 5-pole                 |
| Voltage signal type                   | 24 VDC                                  |
| Input characteristic                  | High-side switching                     |
| Input filter                          | 0.2 ... 20 ms                           |
| Input characteristic                  | Type 3, per IEC 61131-2                 |
| Output current (per channel)          | 2 A (typ.) for DO                       |
| Supply current per port               | 1L: 1 A for IO-Link; 4 A (max.) for DIO |

## Module Power Supply

|                               |  |
|-------------------------------|--|
| Connection technology: supply | 2 x L-coded M12; 5-pole                                |
| Supply voltage                | 24 VDC (18 ... 31.2 V); 1L                             |
| Power consumption (max.)      | 16000 mA   |
| Power consumption (note)      | per supply line; overload- and short-circuit-protected |
| Reverse voltage protection    | Yes  |

## Geometrical Data

|        |                     |
|--------|---------------------|
| Width  | 60 mm / 2.362 inch  |
| Height | 30 mm / 1.181 inch  |
| Depth  | 210 mm / 8.268 inch |

Subject to changes. Please also observe the further product documentation!

## Mechanical Data

|                    |       |
|--------------------|-------|
| Weight             | 610 g |
| Conformity marking | CE    |

## Environmental Requirements

|  |  |
|--|--|
| Surrounding air temperature (operation)  | -25 ... +70 °C   |
| Surrounding air temperature (storage)    | -40 ... +80 °C   |
| Protection type                          | IP67   |
| Protection class                         | III per EN 61140, IEC 61140, VDE 0140-1  |
| Operating altitude                       | 0 ... 2000 m   |
| Pollution degree (5)                     | 3 per EN 60664-1   |
| Overvoltage category                     | II (EN 60664-1)  |
| Relative humidity (without condensation) | 95 %   |
| Vibration resistance                     | 5g per IEC 60068-2-6   |
| Shock resistance                         | Short-term: 50g/11 ms/half-sine per IEC 60068-2-27; Long-term: 30g/6 ms/half-sine per IEC 60068-2-29 |
| EMC immunity to interference             | per EN 61000-6-2   |
| EMC emission of interference             | per EN 61000-6-4   |

## Commercial data

|                       |               |
|-----------------------|---------------|
| PU (SPU)              | 1 Pieces      |
| Country of origin     | DE            |
| GTIN                  | 4055144009996 |
| Customs tariff number | 85371098990   |

## Required accessories

### Cover

|       |   |  |
|-------|---|--|
| Cover |   |  |
|       | <b>Item no.: 756-8102</b><br>M12 protective cap; for unused sockets | <a href="http://www.wago.com/756-8102">www.wago.com/756-8102</a> |
|       | <b>Item no.: 756-8103</b><br>M12 protective cap; for unused plugs   | <a href="http://www.wago.com/756-8103">www.wago.com/756-8103</a> |

### Tool

|               |  |  |
|---------------|--|--|
| Assembly tool |  |  |
|               | <b>Item no.: 206-701</b><br>Torque wrench M8 and M12; Assembly kit | <a href="http://www.wago.com/206-701">www.wago.com/206-701</a> |

Subject to changes. Please also observe the further product documentation!

## Marking accessories

### Marking strip



**Item no.: 2009-110**

Marking strips; for Smart Printer; on reel; not stretchable; plain; snap-on type; white

[www.wago.com/2009-110](http://www.wago.com/2009-110)

### Marker



**Item no.: 2009-115**

WMB-Inline; for Smart Printer; 1500 pieces on roll; stretchable 5 - 5.2 mm; plain; snap-on type; white

[www.wago.com/2009-115](http://www.wago.com/2009-115)

## Optional accessories

### Cables and pluggable connectors

#### Sensor/actuator cable

**Item no.: 756-5402/040-010**

Sensor/Actuator cable; M12A socket; straight; M12A plug; angled; 4-pole; Length: 1 m

[www.wago.com/756-5402/040-010](http://www.wago.com/756-5402/040-010)

**Item no.: 756-5402/040-020**

Sensor/Actuator cable; M12A socket; straight; M12A plug; angled; 4-pole; Length: 2 m

[www.wago.com/756-5402/040-020](http://www.wago.com/756-5402/040-020)

**Item no.: 756-5311/040-050**

Sensor/Actuator cable; M12A plug; straight; 4-pole; Length: 5 m

[www.wago.com/756-5311/040-050](http://www.wago.com/756-5311/040-050)

**Item no.: 756-5311/040-015**

Sensor/Actuator cable; M12A plug; straight; 4-pole; Length: 1.5 m

[www.wago.com/756-5311/040-015](http://www.wago.com/756-5311/040-015)

**Item no.: 756-5311/040-100**

Sensor/Actuator cable; M12A plug; straight; 4-pole; Length: 10 m

[www.wago.com/756-5311/040-100](http://www.wago.com/756-5311/040-100)

**Item no.: 756-5404/040-020**

Sensor/Actuator cable; M12A socket; angled; M12A plug; angled; 4-pole; Length: 2 m

[www.wago.com/756-5404/040-020](http://www.wago.com/756-5404/040-020)

**Item no.: 756-5510/040-010**

Sensor/Actuator cable; M8 socket; angled; M12A plug; angled; 4-pole; Length: 1 m

[www.wago.com/756-5510/040-010](http://www.wago.com/756-5510/040-010)

**Item no.: 756-5510/040-020**

Sensor/Actuator cable; M8 socket; angled; M12A plug; angled; 4-pole; Length: 2 m

[www.wago.com/756-5510/040-020](http://www.wago.com/756-5510/040-020)

**Item no.: 756-5401/040-020**

Sensor/Actuator cable; M12A socket; straight; M12A plug; straight; 4-pole; Length: 2 m

[www.wago.com/756-5401/040-020](http://www.wago.com/756-5401/040-020)

Subject to changes. Please also observe the further product documentation!

WAGO GmbH & Co. KG

Hansastr. 27

32423 Minden

Phone: +49571 887-0 | Fax: +49571 887-169

Email: [info.de@wago.com](mailto:info.de@wago.com) | Web: [www.wago.com](http://www.wago.com)

Do you have any questions about our products?

We are always happy to take your call at +49 (571) 887-44222.

**Item no.: 756-5401/040-010**  
Sensor/Actuator cable; M12A socket; straight; M12A plug; straight; 4-pole; Length: 1 m

[www.wago.com/756-5401/040-010](http://www.wago.com/756-5401/040-010)

**Item no.: 756-5507/040-010**  
Sensor/Actuator cable; M8 socket; straight; M12A plug; straight; 4-pole; Length: 1 m

[www.wago.com/756-5507/040-010](http://www.wago.com/756-5507/040-010)

**Item no.: 756-5507/040-020**  
Sensor/Actuator cable; M8 socket; straight; M12A plug; straight; 4-pole; Length: 2 m

[www.wago.com/756-5507/040-020](http://www.wago.com/756-5507/040-020)

**Item no.: 756-5404/040-010**  
Sensor/Actuator cable; M12A socket; angled; M12A plug; angled; 4-pole; Length: 1 m

[www.wago.com/756-5404/040-010](http://www.wago.com/756-5404/040-010)

**Item no.: 756-5312/040-015**  
Sensor/Actuator cable; M12B socket; straight; 4-pole; Length: 1.5 m

[www.wago.com/756-5312/040-015](http://www.wago.com/756-5312/040-015)

**Item no.: 756-5312/040-050**  
Sensor/Actuator cable; M12B socket; straight; 4-pole; Length: 5 m

[www.wago.com/756-5312/040-050](http://www.wago.com/756-5312/040-050)

**Item no.: 756-5509/040-010**  
Sensor/Actuator cable; M8 socket; angled; M12A plug; straight; 4-pole; Length: 1 m

[www.wago.com/756-5509/040-010](http://www.wago.com/756-5509/040-010)

**Item no.: 756-5509/040-020**  
Sensor/Actuator cable; M8 socket; angled; M12A plug; straight; 4-pole; Length: 2 m

[www.wago.com/756-5509/040-020](http://www.wago.com/756-5509/040-020)

**Item no.: 756-5403/040-010**  
Sensor/Actuator cable; M12A socket; angled; M12A plug; straight; 4-pole; Length: 1 m

[www.wago.com/756-5403/040-010](http://www.wago.com/756-5403/040-010)

**Item no.: 756-5312/040-100**  
Sensor/Actuator cable; M12B socket; straight; 4-pole; Length: 10 m

[www.wago.com/756-5312/040-100](http://www.wago.com/756-5312/040-100)

**Item no.: 756-5403/040-020**  
Sensor/Actuator cable; M12A socket; angled; M12A plug; straight; 4-pole; Length: 2 m

[www.wago.com/756-5403/040-020](http://www.wago.com/756-5403/040-020)



**Item no.: 756-5508/040-010**  
Sensor/Actuator cable; M8 socket; straight; M12A plug; angled; 4-pole; Length: 1 m

[www.wago.com/756-5508/040-010](http://www.wago.com/756-5508/040-010)



**Item no.: 756-5508/040-020**  
Sensor/Actuator cable; M8 socket; straight; M12A plug; angled; 4-pole; Length: 2 m

[www.wago.com/756-5508/040-020](http://www.wago.com/756-5508/040-020)

Configurable connectors

Subject to changes. Please also observe the further product documentation!

**Item no.:** 756-9202/040-000

Fitted pluggable connector; 4-pole; M12 plug, straight, A-coded; Spring

[www.wago.com/756-9202/040-000](http://www.wago.com/756-9202/040-000)

**Item no.:** 756-9205/040-000

Fitted pluggable connector; 4-pole; M12 plug, right angle; Spring

[www.wago.com/756-9205/040-000](http://www.wago.com/756-9205/040-000)



**Item no.:** 756-9711/050-000

Fitted pluggable connector; 5-pole, shielded; M12 socket, straight; IDC technology

[www.wago.com/756-9711/050-000](http://www.wago.com/756-9711/050-000)



**Item no.:** 756-9701/050-000

Fitted pluggable connector; 5-pole, shielded; M12 plug, straight; IDC technology

[www.wago.com/756-9701/050-000](http://www.wago.com/756-9701/050-000)

Configurable shielded connectors

**Item no.:** 756-9501/060-000

Fitted pluggable connector; 5-pole, shielded; M12 plug, straight, D-coded; Spring

[www.wago.com/756-9501/060-000](http://www.wago.com/756-9501/060-000)

**Item no.:** 756-9501/040-000

Accessories; M12 plug, right angle; 4-pole

[www.wago.com/756-9501/040-000](http://www.wago.com/756-9501/040-000)

Power cable



**Item no.:** 756-3501/050-075

Power cable; M12L socket; straight; 5-pole; Length: 7.5 m

[www.wago.com/756-3501/050-075](http://www.wago.com/756-3501/050-075)



**Item no.:** 756-3501/050-100

Power cable; M12L socket; straight; 5-pole; Length: 10 m

[www.wago.com/756-3501/050-100](http://www.wago.com/756-3501/050-100)



**Item no.:** 756-3501/050-150

Power cable; M12L socket; straight; 5-pole; Length: 15 m

[www.wago.com/756-3501/050-150](http://www.wago.com/756-3501/050-150)



**Item no.:** 756-3501/050-050

Power cable; M12L socket; straight; 5-pole; Length: 5 m

[www.wago.com/756-3501/050-050](http://www.wago.com/756-3501/050-050)



**Item no.:** 756-3502/050-050

Power cable; M12L socket; angled; 5-pole; Length: 5 m

[www.wago.com/756-3502/050-050](http://www.wago.com/756-3502/050-050)

Subject to changes. Please also observe the further product documentation!

WAGO GmbH & Co. KG

Hansastr. 27

32423 Minden

Phone: +49571 887-0 | Fax: +49571 887-169

Email: [info.de@wago.com](mailto:info.de@wago.com) | Web: [www.wago.com](http://www.wago.com)

Do you have any questions about our products?

We are always happy to take your call at +49 (571) 887-44222.



**Item no.: 756-3502/050-150**  
Power cable; M12L socket; angled; 5-pole; Length: 15 m

[www.wago.com/756-3502/050-150](http://www.wago.com/756-3502/050-150)



**Item no.: 756-3502/050-075**  
Power cable; M12L socket; angled; 5-pole; Length: 7.5 m

[www.wago.com/756-3502/050-075](http://www.wago.com/756-3502/050-075)



**Item no.: 756-3502/050-100**  
Power cable; M12L socket; angled; 5-pole; Length: 10 m

[www.wago.com/756-3502/050-100](http://www.wago.com/756-3502/050-100)



**Item no.: 756-3503/050-075**  
Power cable; M12L plug; straight; 5-pole; Length: 7.5 m

[www.wago.com/756-3503/050-075](http://www.wago.com/756-3503/050-075)



**Item no.: 756-3503/050-150**  
Power cable; M12L plug; straight; 5-pole; Length: 15 m

[www.wago.com/756-3503/050-150](http://www.wago.com/756-3503/050-150)



**Item no.: 756-3503/050-100**  
Power cable; M12L plug; straight; 5-pole; Length: 10 m

[www.wago.com/756-3503/050-100](http://www.wago.com/756-3503/050-100)



**Item no.: 756-3505/050-003**  
Power cable; M12L socket; straight; M12L plug; straight; 5-pole; Length: 0.3 m

[www.wago.com/756-3505/050-003](http://www.wago.com/756-3505/050-003)



**Item no.: 756-3505/050-005**  
Power cable; M12L socket; straight; M12L plug; straight; 5-pole; Length: 0.5 m

[www.wago.com/756-3505/050-005](http://www.wago.com/756-3505/050-005)



**Item no.: 756-3505/050-020**  
Power cable; M12L socket; straight; M12L plug; straight; 5-pole; Length: 2 m

[www.wago.com/756-3505/050-020](http://www.wago.com/756-3505/050-020)



**Item no.: 756-3505/050-010**  
Power cable; M12L socket; straight; M12L plug; straight; 5-pole; Length: 1 m

[www.wago.com/756-3505/050-010](http://www.wago.com/756-3505/050-010)



**Item no.: 756-3505/050-050**  
Power cable; M12L socket; straight; M12L plug; straight; 5-pole; Length: 5 m













[www.wago.com/756-3505/050-050](http://www.wago.com/756-3505/050-050)



**Item no.: 756-3505/050-075**  
Power cable; M12L socket; straight; M12L plug; straight; 5-pole; Length: 7.5 m







[www.wago.com/756-3505/050-075](http://www.wago.com/756-3505/050-075)

Subject to changes. Please also observe the further product documentation!

|  |  |  |
|--|--|--|
|    | <b>Item no.: 756-3505/050-100</b><br>Power cable; M12L socket; straight; M12L plug; straight; 5-pole; Length: 10 m | <a href="http://www.wago.com/756-3505/050-100">www.wago.com/756-3505/050-100</a> |
|    | <b>Item no.: 756-3506/050-100</b><br>Power cable; M12L socket; angled; M12L plug; angled; 5-pole; Length: 10 m     | <a href="http://www.wago.com/756-3506/050-100">www.wago.com/756-3506/050-100</a> |
|    | <b>Item no.: 756-3506/050-075</b><br>Power cable; M12L socket; angled; M12L plug; angled; 5-pole; Length: 7.5 m    | <a href="http://www.wago.com/756-3506/050-075">www.wago.com/756-3506/050-075</a> |
|    | <b>Item no.: 756-3506/050-150</b><br>Power cable; M12L socket; angled; M12L plug; angled; 5-pole; Length: 15 m     | <a href="http://www.wago.com/756-3506/050-150">www.wago.com/756-3506/050-150</a> |
|    | <b>Item no.: 756-3501/050-020</b><br>Power cable; M12L socket; straight; 5-pole; Length: 2 m                       | <a href="http://www.wago.com/756-3501/050-020">www.wago.com/756-3501/050-020</a> |
|    | <b>Item no.: 756-3502/050-020</b><br>Power cable; M12L socket; angled; 5-pole; Length: 2 m                         | <a href="http://www.wago.com/756-3502/050-020">www.wago.com/756-3502/050-020</a> |
|   | <b>Item no.: 756-3503/050-020</b><br>Power cable; M12L plug; straight; 5-pole; Length: 2 m                         | <a href="http://www.wago.com/756-3503/050-020">www.wago.com/756-3503/050-020</a> |
|  | <b>Item no.: 756-3503/050-050</b><br>Power cable; M12L plug; straight; 5-pole; Length: 5 m                         | <a href="http://www.wago.com/756-3503/050-050">www.wago.com/756-3503/050-050</a> |
|  | <b>Item no.: 756-3504/050-020</b><br>Power cable; M12L plug; angled; 5-pole; Length: 2 m                           | <a href="http://www.wago.com/756-3504/050-020">www.wago.com/756-3504/050-020</a> |
|  | <b>Item no.: 756-3504/050-050</b><br>Power cable; M12L plug; angled; 5-pole; Length: 5 m                           | <a href="http://www.wago.com/756-3504/050-050">www.wago.com/756-3504/050-050</a> |
|  | <b>Item no.: 756-3504/050-075</b><br>Power cable; M12L plug; angled; 5-pole; Length: 7.5 m                         | <a href="http://www.wago.com/756-3504/050-075">www.wago.com/756-3504/050-075</a> |
|  | <b>Item no.: 756-3504/050-100</b><br>Power cable; M12L plug; angled; 5-pole; Length: 10 m                          | <a href="http://www.wago.com/756-3504/050-100">www.wago.com/756-3504/050-100</a> |

Subject to changes. Please also observe the further product documentation!



|  |  |  |
|--|--|--|
|   | <b>Item no.: 756-3504/050-150</b><br>Power cable; M12L plug; angled; 5-pole; Length: 15 m                                    | <a href="http://www.wago.com/756-3504/050-150">www.wago.com/756-3504/050-150</a> |
|    | <b>Item no.: 756-3505/050-150</b><br>Power cable; M12L socket; straight; M12L plug; straight; 5-pole; Length: 15 m           | <a href="http://www.wago.com/756-3505/050-150">www.wago.com/756-3505/050-150</a> |
|   | <b>Item no.: 756-3506/050-003</b><br>Power cable; M12L socket; angled; M12L plug; angled; 5-pole; Length: 0.3 m              | <a href="http://www.wago.com/756-3506/050-003">www.wago.com/756-3506/050-003</a> |
|   | <b>Item no.: 756-3506/050-005</b><br>Power cable; M12L socket; angled; M12L plug; angled; 5-pole; Length: 0.5 m              | <a href="http://www.wago.com/756-3506/050-005">www.wago.com/756-3506/050-005</a> |
|   | <b>Item no.: 756-3506/050-020</b><br>Power cable; M12L socket; angled; M12L plug; angled; 5-pole; Length: 2 m                | <a href="http://www.wago.com/756-3506/050-020">www.wago.com/756-3506/050-020</a> |
|   | <b>Item no.: 756-3506/050-010</b><br>Power cable; M12L socket; angled; M12L plug; angled; 5-pole; Length: 1 m                | <a href="http://www.wago.com/756-3506/050-010">www.wago.com/756-3506/050-010</a> |
|  | <b>Item no.: 756-3506/050-050</b><br>Power cable; M12L socket; angled; M12L plug; angled; 5-pole; Length: 5 m                | <a href="http://www.wago.com/756-3506/050-050">www.wago.com/756-3506/050-050</a> |
| <b>Distribution connector</b>  |  |  |
|  | <b>Item no.: 756-5513/040-010</b><br>Sensor/Actuator cable; 2xM8 socket; straight; M12A plug; straight; 4-pole; Length: 1 m  | <a href="http://www.wago.com/756-5513/040-010">www.wago.com/756-5513/040-010</a> |
|  | <b>Item no.: 756-5513/040-020</b><br>Sensor/Actuator cable; 2xM8 socket; straight; M12A plug; straight; 4-pole; Length: 2 m  | <a href="http://www.wago.com/756-5513/040-020">www.wago.com/756-5513/040-020</a> |
|  | <b>Item no.: 756-5514/040-010</b><br>Sensor/Actuator cable; 2xM8 socket; angled; M12A plug; straight; 4-pole; Length: 1 m    | <a href="http://www.wago.com/756-5514/040-010">www.wago.com/756-5514/040-010</a> |
|  | <b>Item no.: 756-5514/040-020</b><br>Sensor/Actuator cable; 2xM8 socket; angled; M12A plug; straight; 4-pole; Length: 2 m    | <a href="http://www.wago.com/756-5514/040-020">www.wago.com/756-5514/040-020</a> |
|  | <b>Item no.: 756-5516/040-010</b><br>Sensor/Actuator cable; 2xM12 socket; straight; M12A plug; straight; 4-pole; Length: 1 m | <a href="http://www.wago.com/756-5516/040-010">www.wago.com/756-5516/040-010</a> |
|  | <b>Item no.: 756-5516/040-020</b><br>Sensor/Actuator cable; 2xM12 socket; straight; M12A plug; straight; 4-pole; Length: 2 m | <a href="http://www.wago.com/756-5516/040-020">www.wago.com/756-5516/040-020</a> |

Subject to changes. Please also observe the further product documentation!

Item no.: 756-5517/040-010

Sensor/Actuator cable; 2xM12 socket; angled; M12A plug; straight; 4-pole; Length: 1 m

[www.wago.com/756-5517/040-010](http://www.wago.com/756-5517/040-010)

Item no.: 756-5517/040-020

Sensor/Actuator cable; 2xM12 socket; angled; M12A plug; straight; 4-pole; Length: 2 m

[www.wago.com/756-5517/040-020](http://www.wago.com/756-5517/040-020)



Item no.: 756-9301/050-000

Accessories; 5-pole

[www.wago.com/756-9301/050-000](http://www.wago.com/756-9301/050-000)

Item no.: 756-9301/040-000

Accessories; 4-pole

[www.wago.com/756-9301/040-000](http://www.wago.com/756-9301/040-000)

ETHERNET/PROFINET cable



Item no.: 756-1202/060-200

ETHERNET cable; M12D plug; angled; 4-pole; Length: 20 m

[www.wago.com/756-1202/060-200](http://www.wago.com/756-1202/060-200)



Item no.: 756-1201/060-100

ETHERNET cable; M12D plug; straight; 4-pole; Length: 10 m

[www.wago.com/756-1201/060-100](http://www.wago.com/756-1201/060-100)



Item no.: 756-1201/060-050

ETHERNET cable; M12D plug; straight; 4-pole; Length: 5 m

[www.wago.com/756-1201/060-050](http://www.wago.com/756-1201/060-050)



Item no.: 756-1203/060-050

ETHERNET cable; M12D plug; straight; M12D plug; straight; 4-pole; Length: 5 m

[www.wago.com/756-1203/060-050](http://www.wago.com/756-1203/060-050)



Item no.: 756-1203/060-020

ETHERNET cable; M12D plug; straight; M12D plug; straight; 4-pole; Length: 2 m

[www.wago.com/756-1203/060-020](http://www.wago.com/756-1203/060-020)



Item no.: 756-1202/060-020

ETHERNET cable; M12D plug; angled; 4-pole; Length: 2 m

[www.wago.com/756-1202/060-020](http://www.wago.com/756-1202/060-020)



Item no.: 756-1201/060-200

ETHERNET cable; M12D plug; straight; 4-pole; Length: 20 m

[www.wago.com/756-1201/060-200](http://www.wago.com/756-1201/060-200)

Subject to changes. Please also observe the further product documentation!

WAGO GmbH & Co. KG

Hansastr. 27











32423 Minden

Phone: +49571 887-0 | Fax: +49571 887-169

Email: [info.de@wago.com](mailto:info.de@wago.com) | Web: [www.wago.com](http://www.wago.com)

Do you have any questions about our products?

We are always happy to take your call at +49 (571) 887-44222.

|  |   |  |
|--|---|--|
|    | <b>Item no.: 756-1204/060-050</b><br>ETHERNET cable; M12D plug; angled; M12D plug; angled; 4-pole; Length: 5 m      | <a href="http://www.wago.com/756-1204/060-050">www.wago.com/756-1204/060-050</a> |
|    | <b>Item no.: 756-1204/060-100</b><br>ETHERNET cable; M12D plug; angled; M12D plug; angled; 4-pole; Length: 10 m     | <a href="http://www.wago.com/756-1204/060-100">www.wago.com/756-1204/060-100</a> |
|    | <b>Item no.: 756-1204/060-200</b><br>ETHERNET cable; M12D plug; angled; M12D plug; angled; 4-pole; Length: 20 m     | <a href="http://www.wago.com/756-1204/060-200">www.wago.com/756-1204/060-200</a> |
|    | <b>Item no.: 756-1203/060-200</b><br>ETHERNET cable; M12D plug; straight; M12D plug; straight; 4-pole; Length: 20 m | <a href="http://www.wago.com/756-1203/060-200">www.wago.com/756-1203/060-200</a> |
|    | <b>Item no.: 756-1203/060-100</b><br>ETHERNET cable; M12D plug; straight; M12D plug; straight; 4-pole; Length: 10 m | <a href="http://www.wago.com/756-1203/060-100">www.wago.com/756-1203/060-100</a> |
|    | <b>Item no.: 756-1204/060-010</b><br>ETHERNET cable; M12D plug; angled; M12D plug; angled; 4-pole; Length: 0.1 m    | <a href="http://www.wago.com/756-1204/060-010">www.wago.com/756-1204/060-010</a> |
|   | <b>Item no.: 756-1204/060-030</b><br>ETHERNET cable; M12D plug; angled; M12D plug; angled; 4-pole; Length: 3 m      | <a href="http://www.wago.com/756-1204/060-030">www.wago.com/756-1204/060-030</a> |
|  | <b>Item no.: 756-1204/060-020</b><br>ETHERNET cable; M12D plug; angled; M12D plug; angled; 4-pole; Length: 2 m      | <a href="http://www.wago.com/756-1204/060-020">www.wago.com/756-1204/060-020</a> |
|  | <b>Item no.: 756-1202/060-050</b><br>ETHERNET cable; M12D plug; angled; 4-pole; Length: 5 m                         | <a href="http://www.wago.com/756-1202/060-050">www.wago.com/756-1202/060-050</a> |
|  | <b>Item no.: 756-1202/060-100</b><br>ETHERNET cable; M12D plug; angled; 4-pole; Length: 10 m                        | <a href="http://www.wago.com/756-1202/060-100">www.wago.com/756-1202/060-100</a> |
|  | <b>Item no.: 756-1201/060-020</b><br>ETHERNET cable; M12D plug; straight; 4-pole; Length: 2 m                       | <a href="http://www.wago.com/756-1201/060-020">www.wago.com/756-1201/060-020</a> |

## Downloads

### Documentation

#### Manual

Subject to changes. Please also observe the further product documentation!



|   |                       |               |          |
|---|-----------------------|---------------|----------|
| 8-Port IO-Link Master Class A; EtherNet/IP<br>DC 24 V / 2.0 A; 8xM12 Connection; WideLine | V 1.1.0<br>2021年4月20日 | pdf<br>7.3 MB | Download |
|---|-----------------------|---------------|----------|

### System Description

|  |  |                 |          |
|--|--|-----------------|----------|
| WAGO I/O System Field; General Product Information |  | pdf<br>708.2 kB | Download |
|--|--|-----------------|----------|

## Engineering-Software

### WAGO IO-Link Configurator

|                           |                           |                 |          |
|---------------------------|---------------------------|-----------------|----------|
| WAGO IO-Link Configurator | V5.1.1-6015<br>2021年8月24日 | ZIP<br>159.6 MB | Download |
|---------------------------|---------------------------|-----------------|----------|

WAGO IO-Link Configurator allows configuration, parameterization, operation and monitoring of WAGO IO-Link Masters in the WAGO I/O System 750 and WAGO I/O System Field, and especially of the WAGO IO-Link devices connected to them.

Additionally, WAGO IO-Link Configurator can be used for complete configuration and operation of all IO-Link devices of third-party manufacturers, as long as they comply with the IO-Link specification. A product's process data can be visualized graphically and stored in trend curves. Up to eight elements can be selected for visualization, and the data can be recorded for up to 24 hours.

Device description files for the IO-Link Masters (IOLM) or IO-Link Devices (IODD) can be used to integrate new devices into the tool at any time. Convenient access to the IO-Link user organization's IODDfinder is available for the IODDs. This allows automated, selective download of IODDs when integrating new IO-Link devices. An integrated IODD viewer allows detailed insight into the IODD device description.

WAGO IO-Link Configurator can be used either as a standalone program or integrated into engineering systems with a TCI interface and *WAGO-I/O-CHECK*.

**IO-Link Configurator can also be used to integrate the IO-Link Master (750-657) of the WAGO I/O System 750 Series and to access all the configurator's functions. This is made possible by the WAGO I/O System 750 IO-Link Adapter, which can be retrofitted. The WAGO I/O System 750 IO-Link Adapter requires the current version of WAGO IO-Link Configurator and a current version of WAGO-I/O-CHECK.**

In addition, the download file contains the device descriptions for the respective fieldbus systems of the WAGO I/O System Field modules. These are pre-installed in the Configurator setup.

The WAGO IO-Link Configurator license is assigned to the specific PC on which it is installed (a workstation license).

Register now and test our engineering software for 30 days at no cost.

## Runtime Software

### Firmware

|  |                    |                |          |
|--|--------------------|----------------|----------|
| Ethernet/IP IO-Field 765-x5xx Firmware Download<br>WAGO_FW0765-x5xx_V01010011_IX01.zip | V 01<br>2021年7月23日 | zip<br>41.3 MB | Download |
|--|--------------------|----------------|----------|

Subject to changes. Please also observe the further product documentation!



## CAD/CAE-Data

### CAD data

|                               |     |          |
|-------------------------------|-----|----------|
| 2D/3D Models 765-4501/100-000 | URL | Download |
|-------------------------------|-----|----------|

## Device Files

### Device Description File

|  |                 |                 |          |
|--|-----------------|-----------------|----------|
| 750-915; EDS-Dateien for EthernetIP / Serie 750, 765 and 767 | 12<br>2021年7月9日 | zip<br>168.4 kB | Download |
| Gerätebeschreibungsdateien 765-45xx, 765-15xx, EtherNet/IP   | V1_1_0_11       | zip<br>74 B     | Download |

## Environmental Product Compliance

### Compliance Search

|   |     |          |
|---|-----|----------|
| Environmental Product Compliance 765-4501/100-000<br>8-Port-IO Link Master Class A; EtherNet/IP; DC 24 V / 2.0 A; 8xM12 connection;<br>WideLine | URL | Download |
|---|-----|----------|

## Installation Notes

### Product family

**WAGO I/O System Field**  
[Show all products from the family](#)

Subject to changes. Please also observe the further product documentation!